

# DESKTOP SYSTEM V

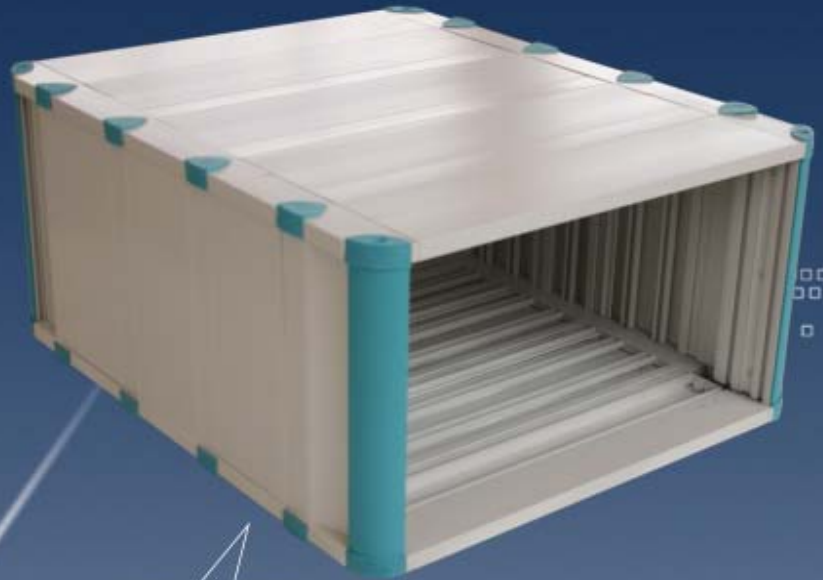

01S

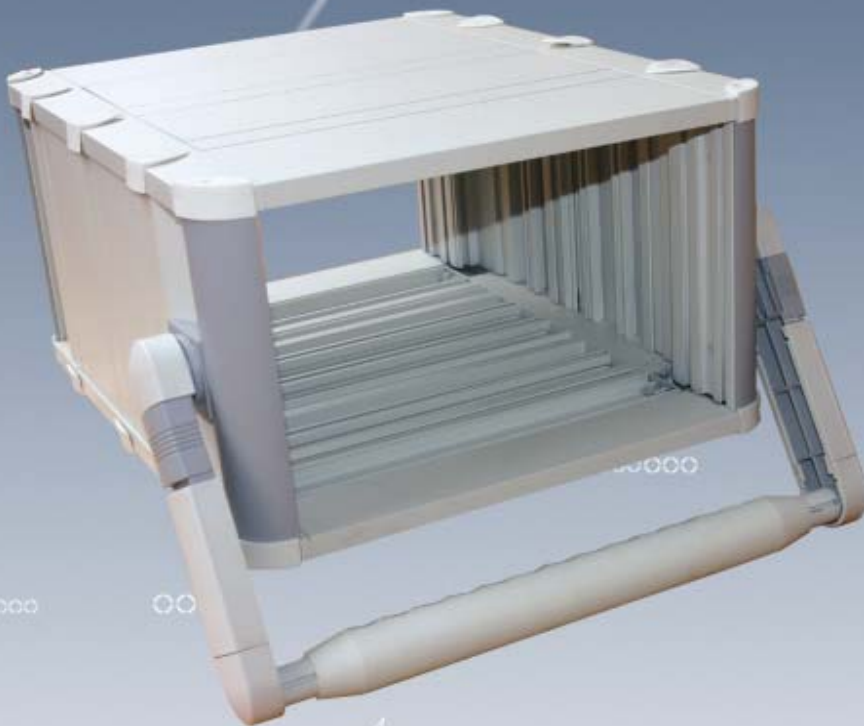

01S-T5

## Available size

### Height/Width Chart of 01S

Exterior size		Interior size		Panel size
Overall height	Overall width	Inside height	Inside width	Front / rear panel blank size
H	L	h	l	B × A
2U	238	62	163	172.5 × 61.5
2U	345	62	272	279.5 × 61.5
2U	452	62	379	386.5 × 61.5
3U	238	107	163	172.5 × 106.5
3U	345	107	272	279.5 × 106.5
3U	452	107	379	386.5 × 106.5
4U	238	151	163	172.5 × 150.5
4U	345	151	272	279.5 × 150.5
4U	452	151	379	386.5 × 150.5

Note: Overall Depth T= 300+29m+120n

The dimensions shown in the table are only for reference (maybe exist ± 0.5mm dimensions variation)

Custom the overall height and the overall width available upon request

The front panel and the rear panel are interchangeable

Refer to the following drawing for the definition of enclosure size

#### Drawing

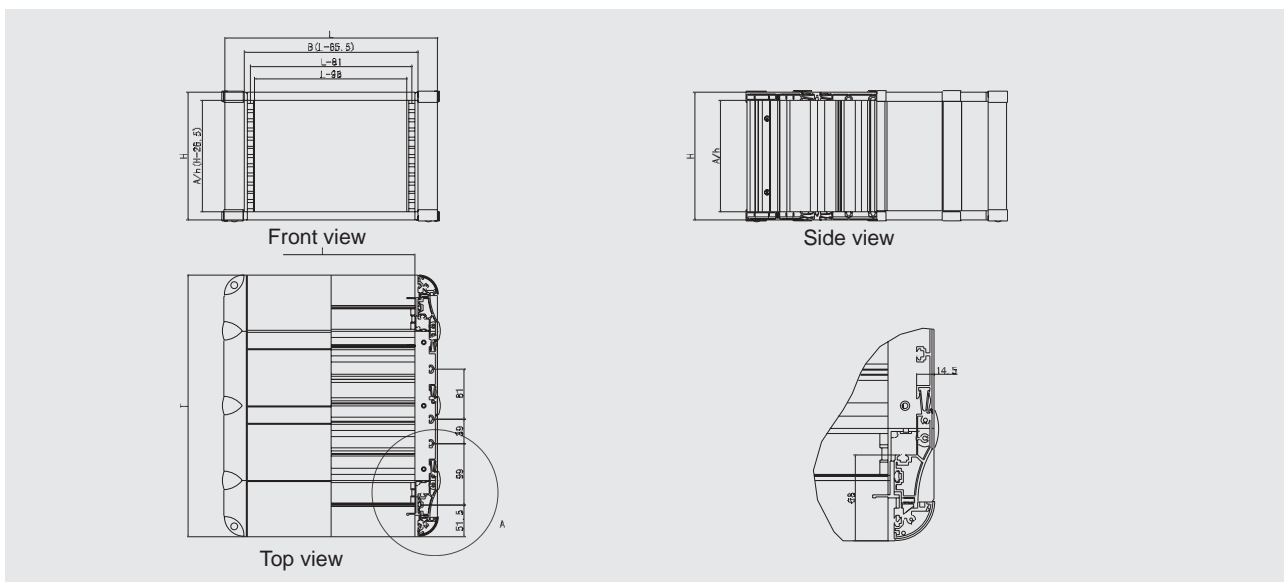

## Standard delivery

### For 01S



## 01 Instrumented case system I

ITEM	PART	QTY	DESCRIPTION
1	Top cover assembly	1	Aluminium extrusions construction
2	Bottom coner feet	4	Moulded in rubber plastic
3	Top coner feet	2	Moulded in rubber plastic
4	Top feet	1	Moulded in rubber plastic
5	Side plate assembly	2	Aluminium extrusions construction
6	Bottom feet	4	Moulded in rubber plastic

## Optional accessories

### Side threaded strip

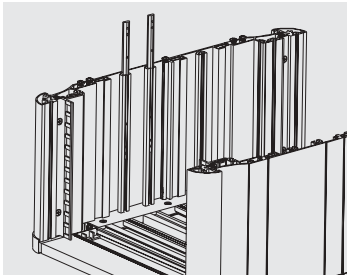

- Material: Aluminium extrusion
- Clear anodized
- Suitable for installation of side
- P.C.B.

### Mounting rail



- Material: Aluminium extrusion
- Clear anodized
- Suitable for static or pull-out installation of P.C.B.

### Side rack

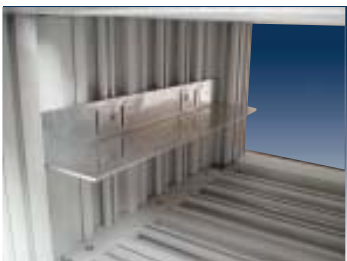

- Material: 1.5mm steel sheet
- To support heavier equipment

### Mounting angle



- Material: Aluminium extrusion
- Clear anodized
- For installation of panels

## 01 Instrumented case system I

### Captive nut



- For fastening panel or subrack enclosure

### Horizontal handle

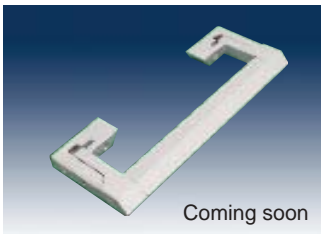

- Material: Die-cast aluminium and extruded aluminium
- For convenience of transportation

### Carrying handle

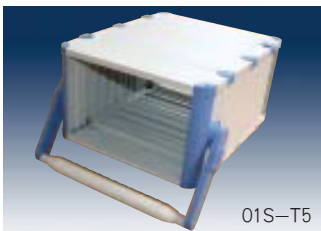

- Can be adjusted in 30 degree increments
- For portable use as well as supporting the enclosure

### Colors configuration

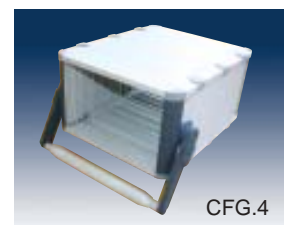
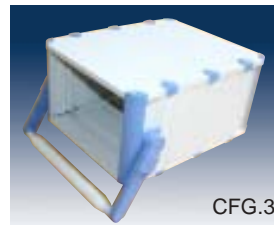
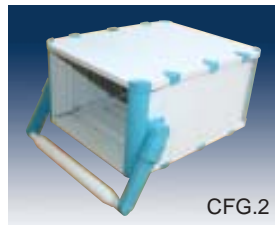
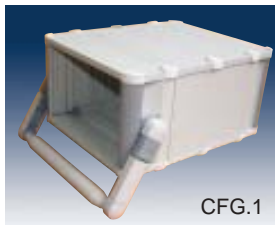

CFG.	Feet	Door bar	Carrying handle	Covers	Side plate
1	Mid-gray	Mid-gray	Mid-gray	Gray-white	Gray-white
2	Green	Green	Green	Gray-white	Gray-white
3	Blue	Blue	Blue	Gray-white	Gray-white
4	Thick-gray	Thick-gray	Thick-gray	Gray-white	Gray-white
5	Champagne	Champagne	Champagne	Gray-white	Gray-white

Note: 1. You may provide us with the card of your desired color if specifying the non-standard colors.

### How to order

Ordering the changhe enclosures is very simple. You only need to tell us the following information.

1. Model of the enclosure
2. H, L and T
3. The colors configuration of the enclosure
4. Optional accessories

Example: Model: 01S